

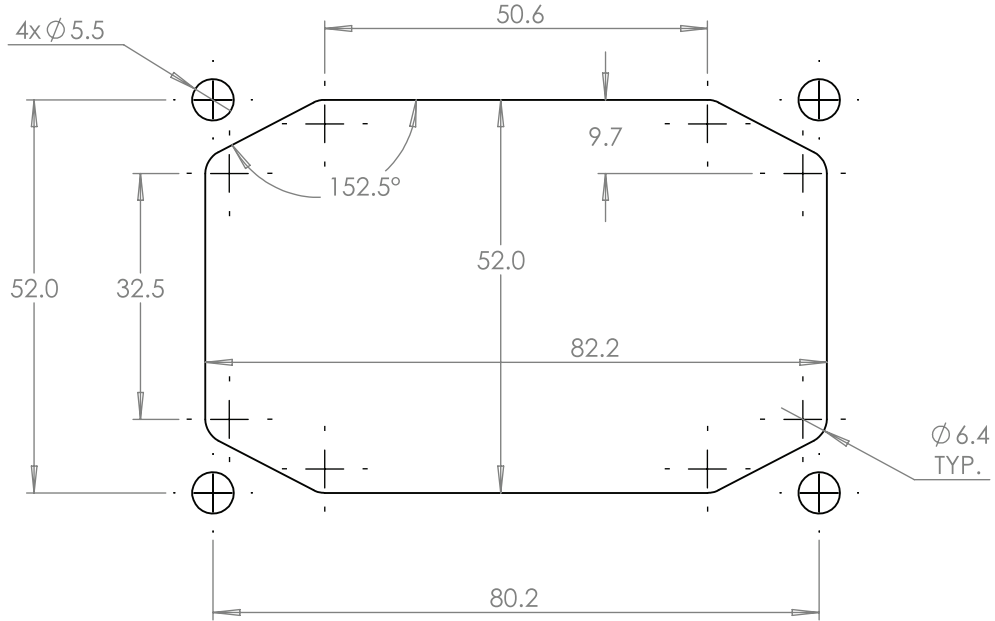

2BANGER FLUSH MOUNT TEMPLATE

FLUSH WITHOUT 15-DEG. WEDGE:



WHEN USING THE 15-DEG. WEDGE:

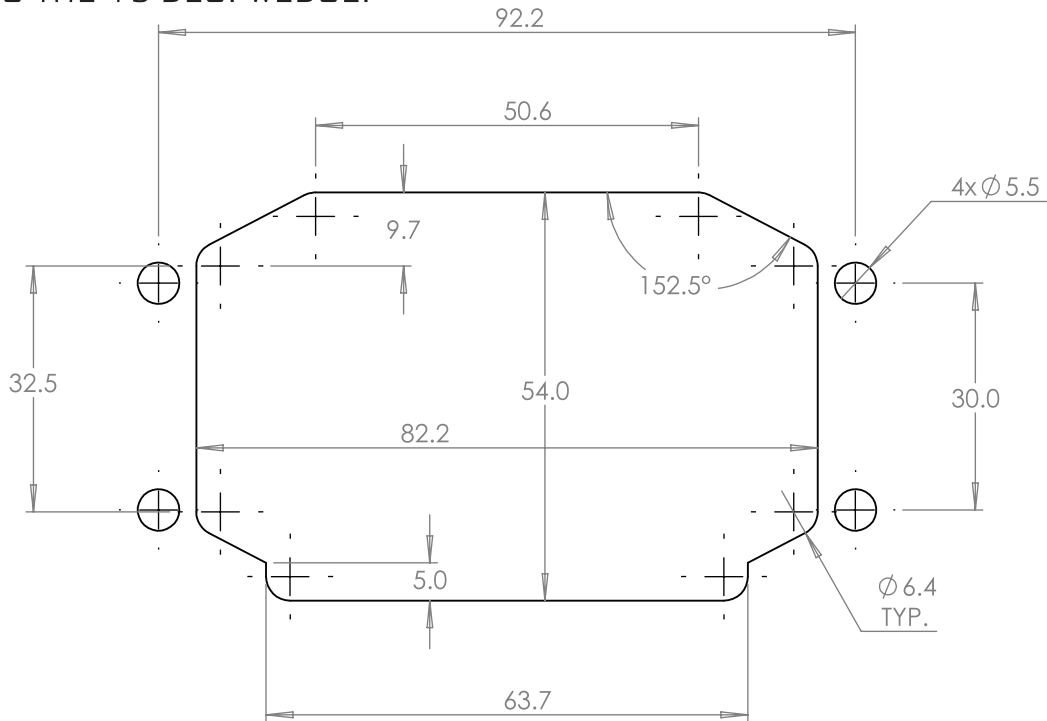

UNLESS OTHERWISE STATED:

DIMENSIONS ARE IN MILLIMETERS

TOLERANCES:

BEND ANGLES:	X°	±0.5°
DIMENSION:	X.X	±0.3
DIMENSION:	X.XX	±0.12