

2016-18 SILVERADO HD XB LED HEADLIGHTS INSTALL GUIDE

WARNING: By reading this document, you agree it is only to be used as an educational guide. Morimoto Lighting nor its dealers make guarantees on any finished results, nor are they to be held responsible for any damage, misuse, or personal injuries. If you are unable to clearly understand and adapt the information below, professional installation is recommended.

PACKAGE CONTENTS

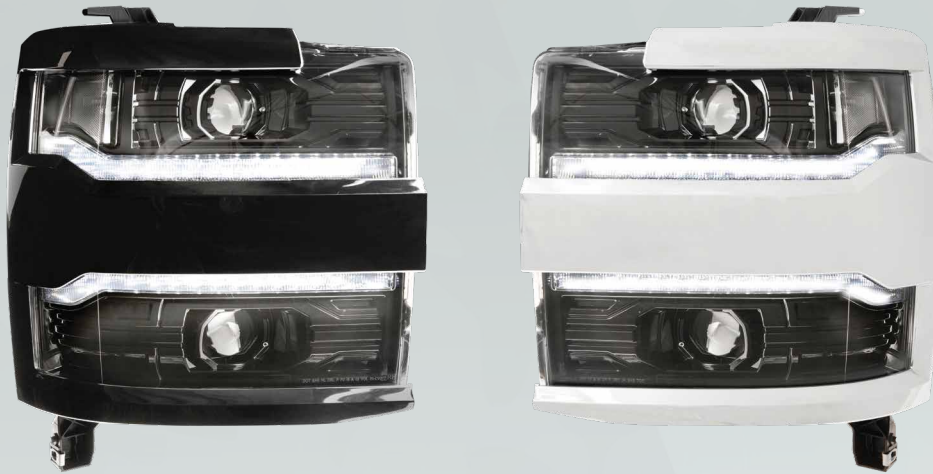

**2X HEADLIGHT ASSEMBLIES
W/ CHROME OR BLACK TRIM**



1 X FUSE TAP / DRL HARNESS

IMPORTANT: If your vehicle is equipped with anything but OEM turn signals (full assemblies, LED bulbs, or otherwise) in the tail lights or elsewhere: You may experience a hyper flash and/or problem with the sequential signal setting on these headlights. This is not a defect in the headlight, and caused by un-matched impedance with your original vehicle settings.

2016-2018 CHEVROLET SILVERADO HD



REQUIRED TOOLS

- RATCHET
- 10MM SOCKET
- T15 TORX
- T20 TORX
- FLAT HEAD SCREWDRIVER OR TRIM REMOVAL TOOL
- PHILIPS HEAD SCREWDRIVER
- NEEDLE NOSE PLIERS

INSTALLATION PROCESS

1. Remove the eleven (11) plastic clips holding on the grille cover and remove it off the truck.

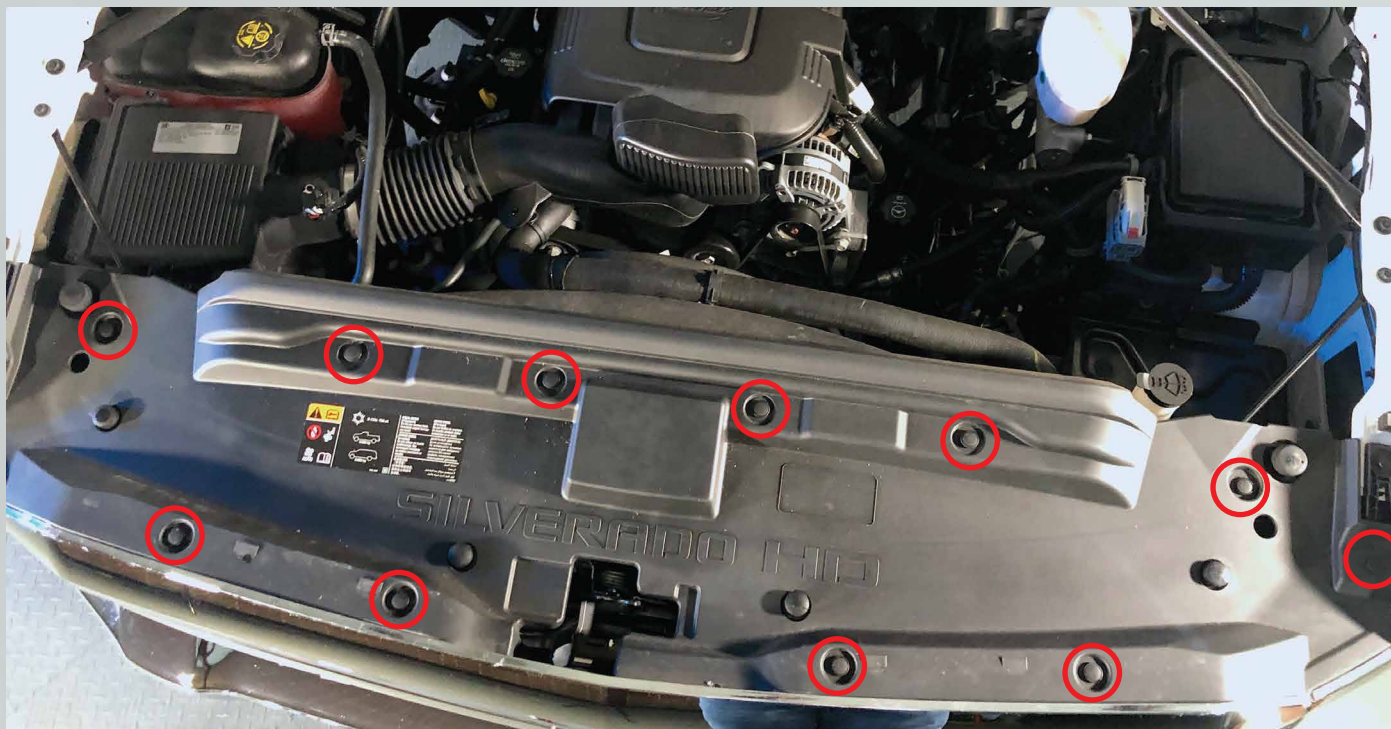

2. Remove the four (4) 10mm bolts holding the top of the grille.

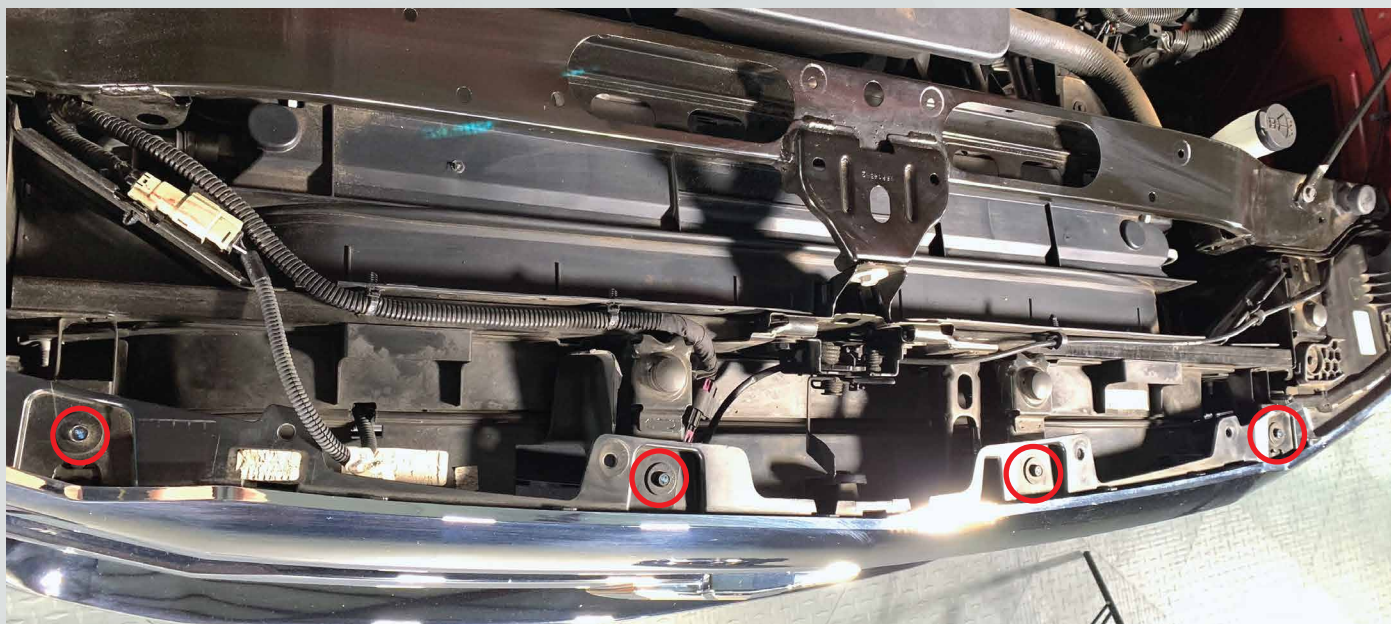

3. Pry up under these four (4) tabs with a flat head screwdriver to release the top of the grille.

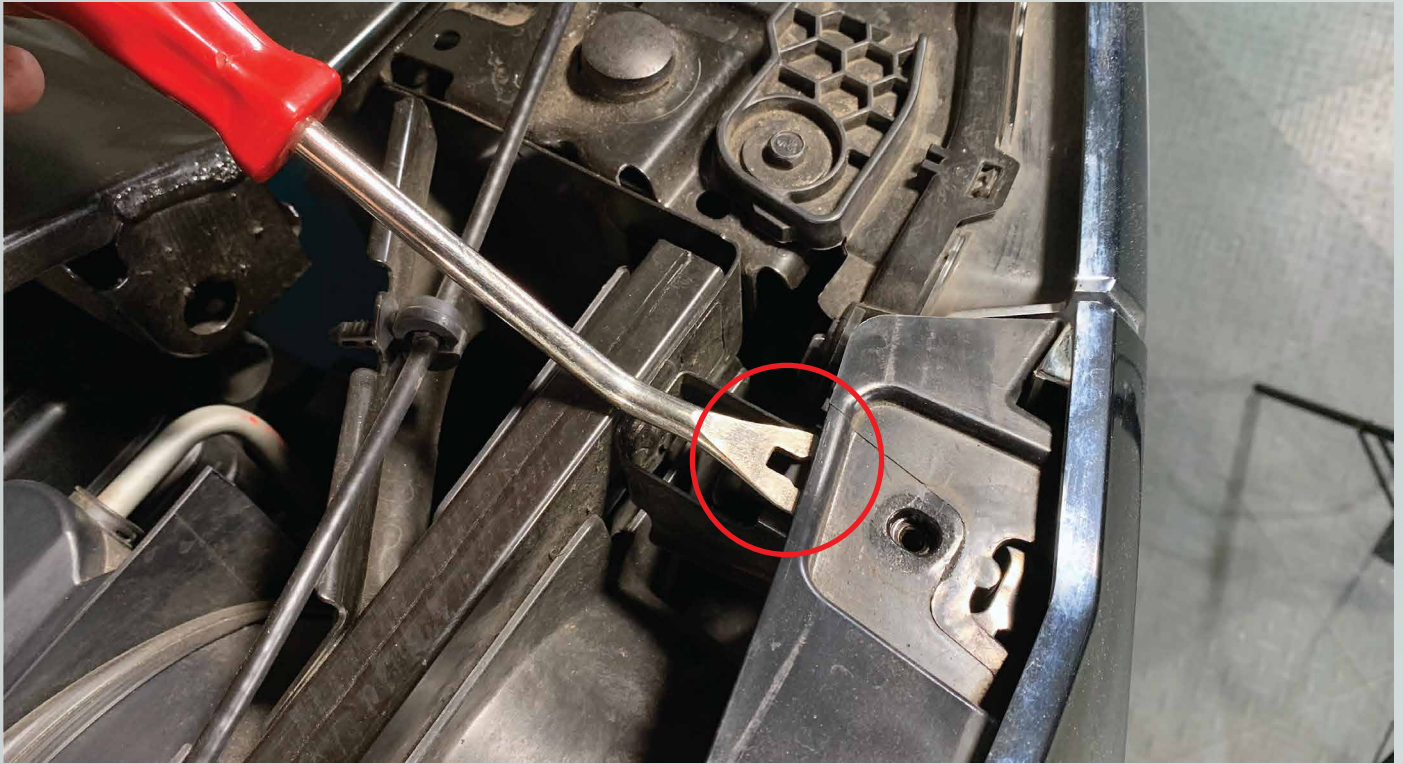

4. Pry the grille forward, with a flat screwdriver, in these spots to release the bottom of the grille. Remove the grille off of the truck.

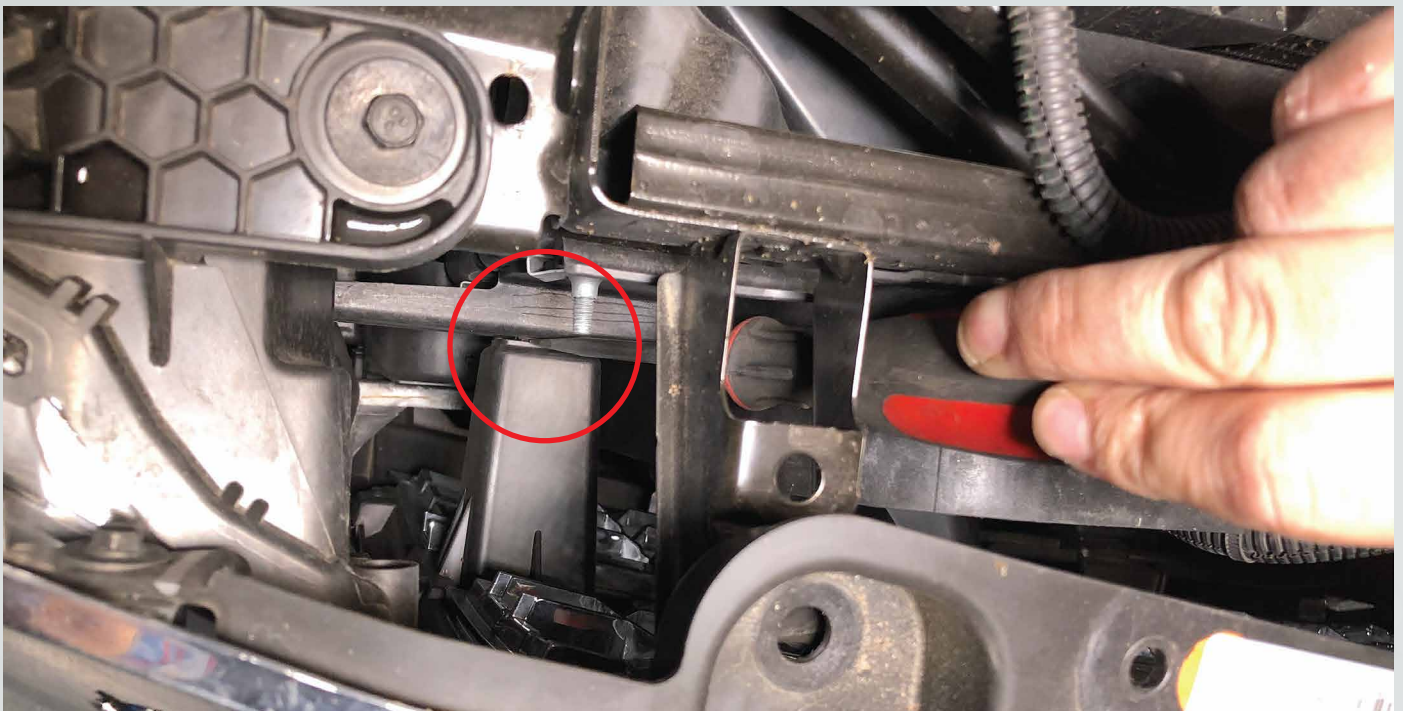

5. Remove one (1) T15 Torx holding the fender liner to the bumper, and pull back the fender liner.



6. Once the fender liner is pulled back, look up and you will see this bolt. Remove this one (1) 10mm bolt holding the headlight to the fender.



7. Remove one (1) 10mm bolt from the bottom inner tab of the headlight.

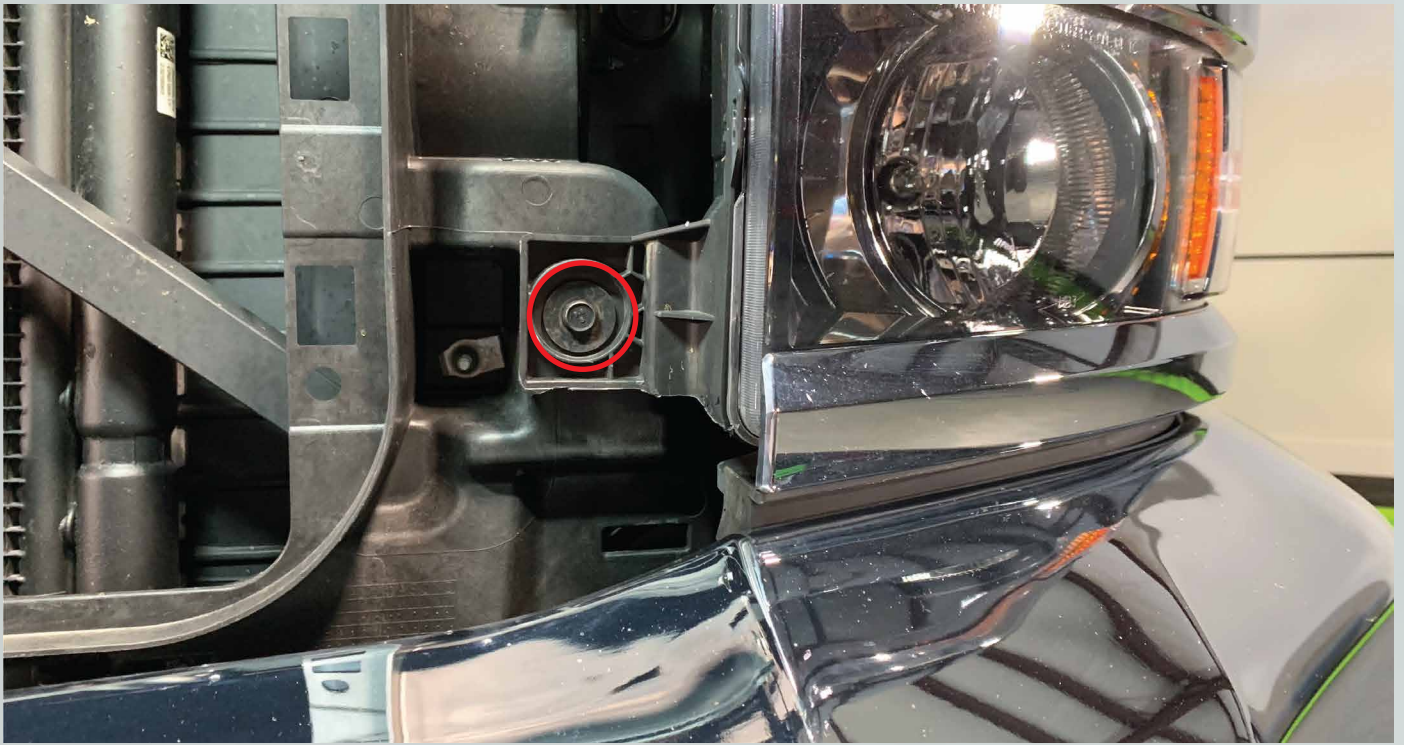

8. Remove the two (2) 10mm bolts from the top of the headlight (red). Then pry up on the outer tab to release the headlight (green), and pull the headlight forward to remove it.

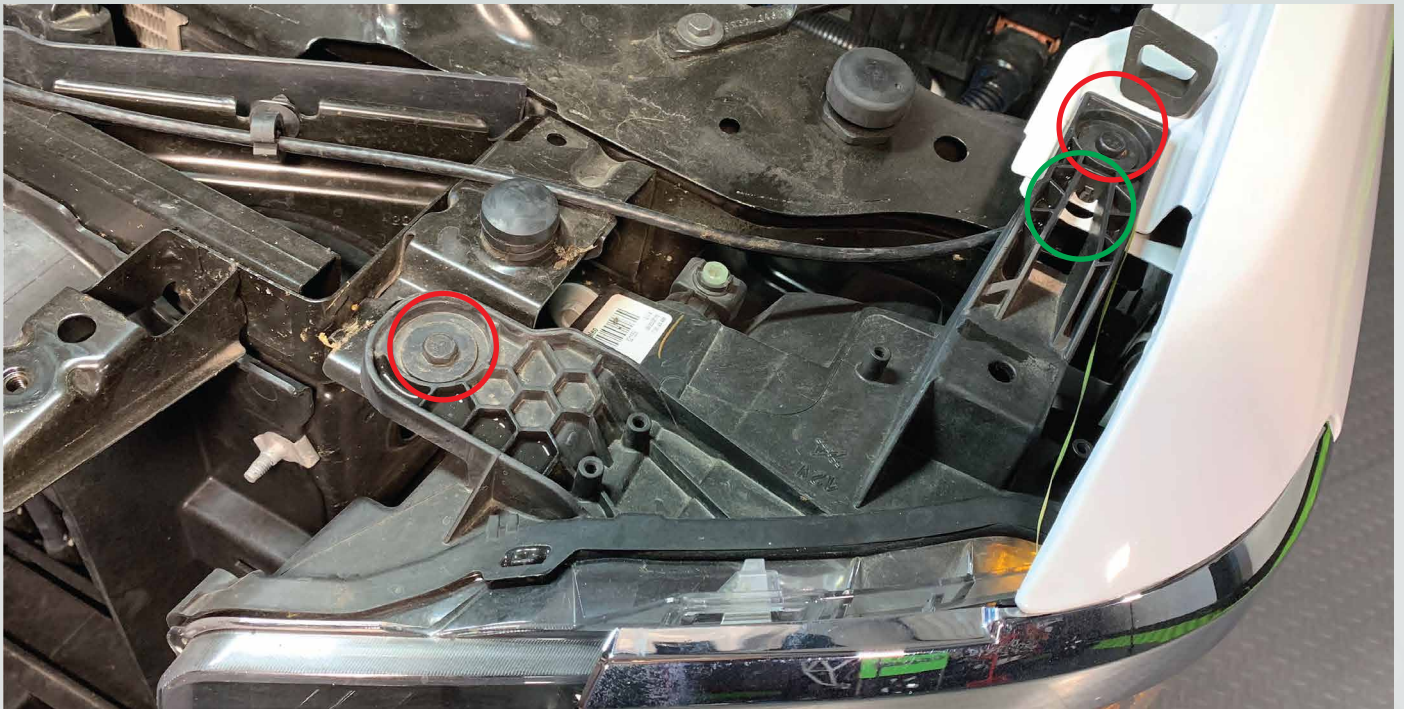

9. Unplug the electrical connector by pressing down the release tab and pulling it away from the headlight.

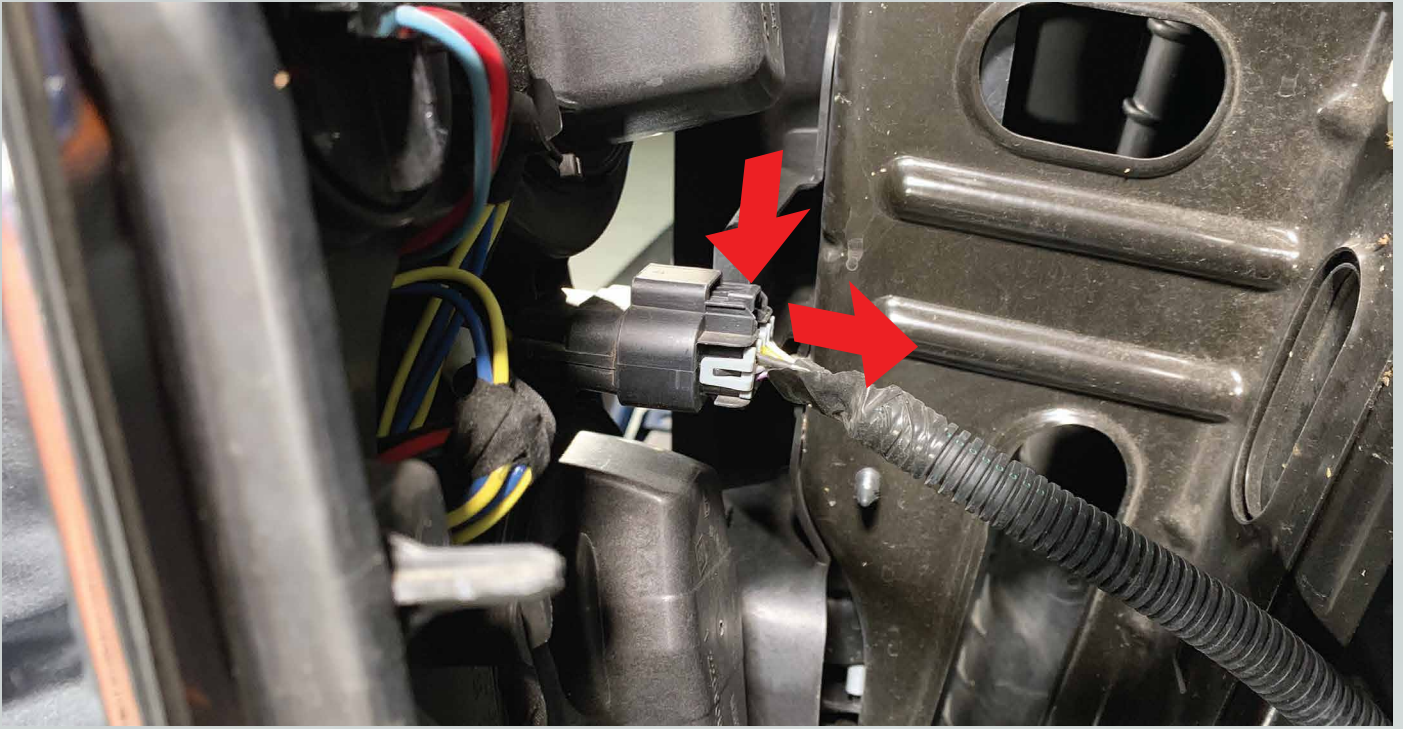

10. Repeat steps #5-9 to remove the headlight on the other side of the truck.

11. Locate the included bezel for the XB headlights. Peel the double sided tape backing on one bezel.

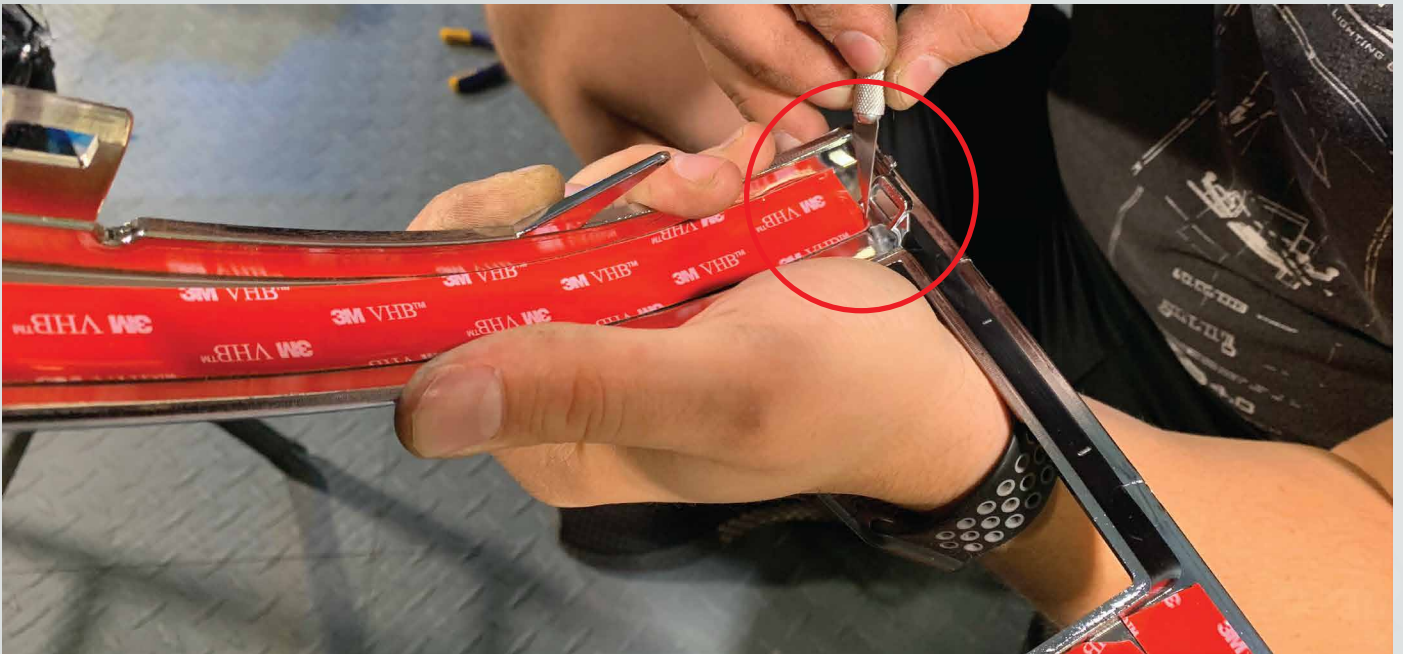

12. Align the top and bottom tabs on the xb headlight with the tabs on the bezel and press the bezel on firmly.

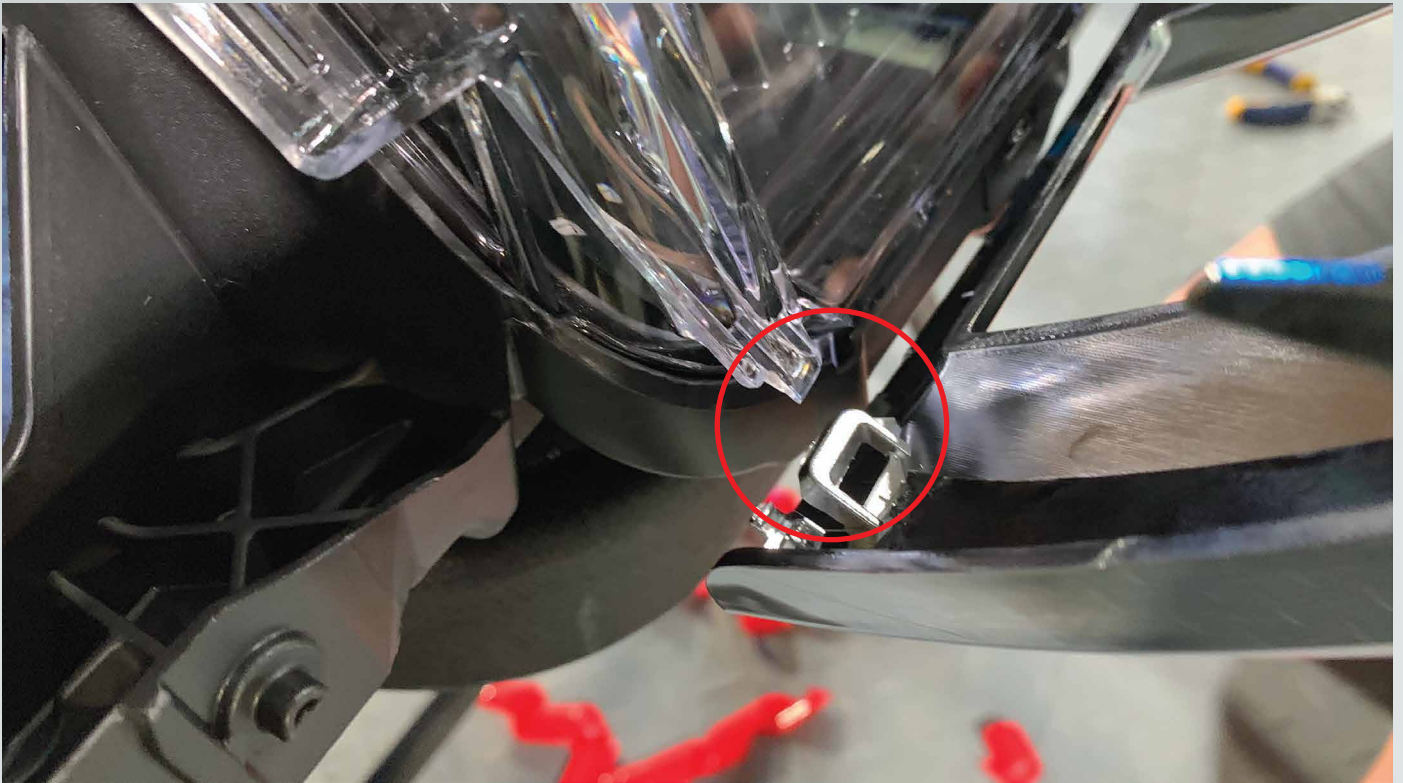
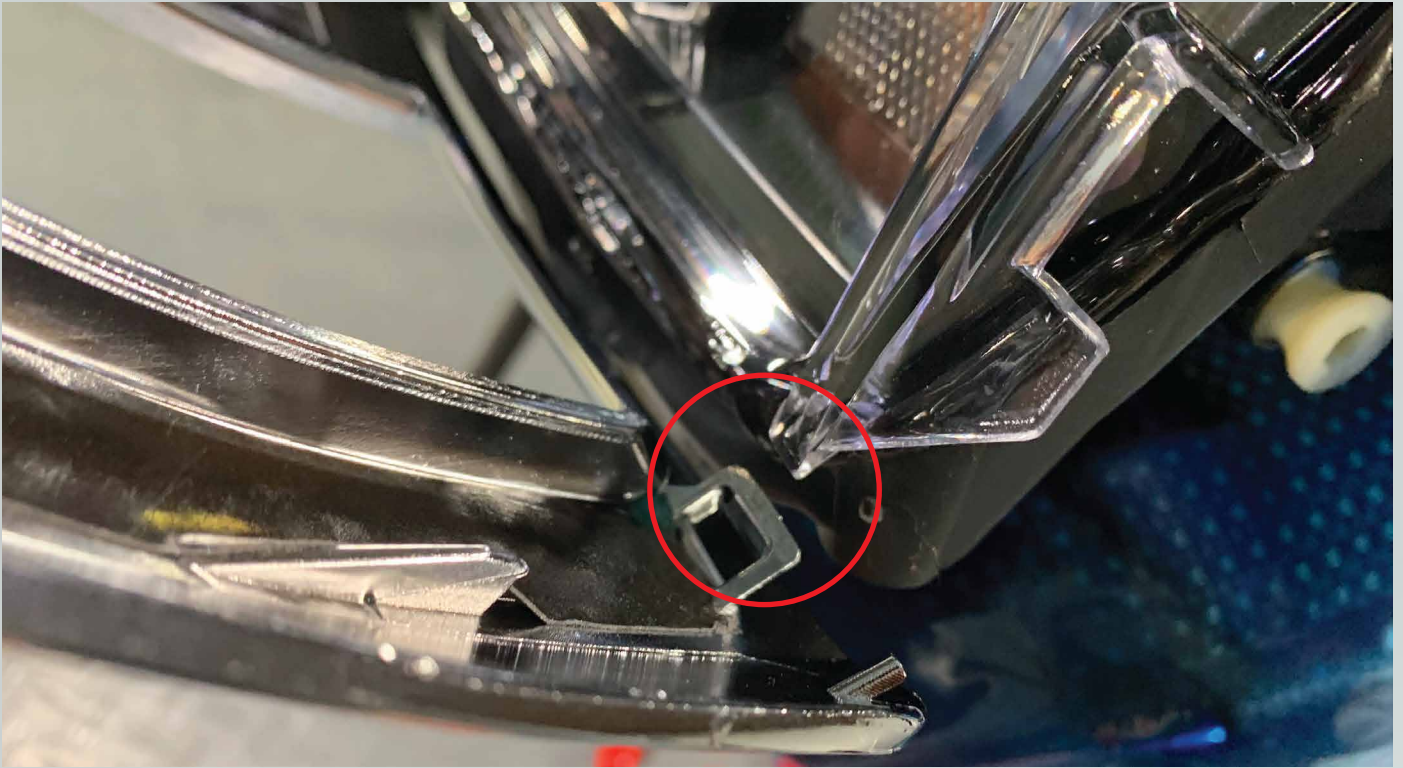

13. Press down on the bezel so the tabs lock into the headlight lens.



14. Remove the three (3) T20 Torx screws on the bottom of the stock headlight and remove the bracket. Transfer the bracket and screws over to the XB headlight.



15. Repeat steps #11-14 on the other XB headlight.

16. Locate the fuse box behind the driver side headlight and remove fuse #30 (10A).

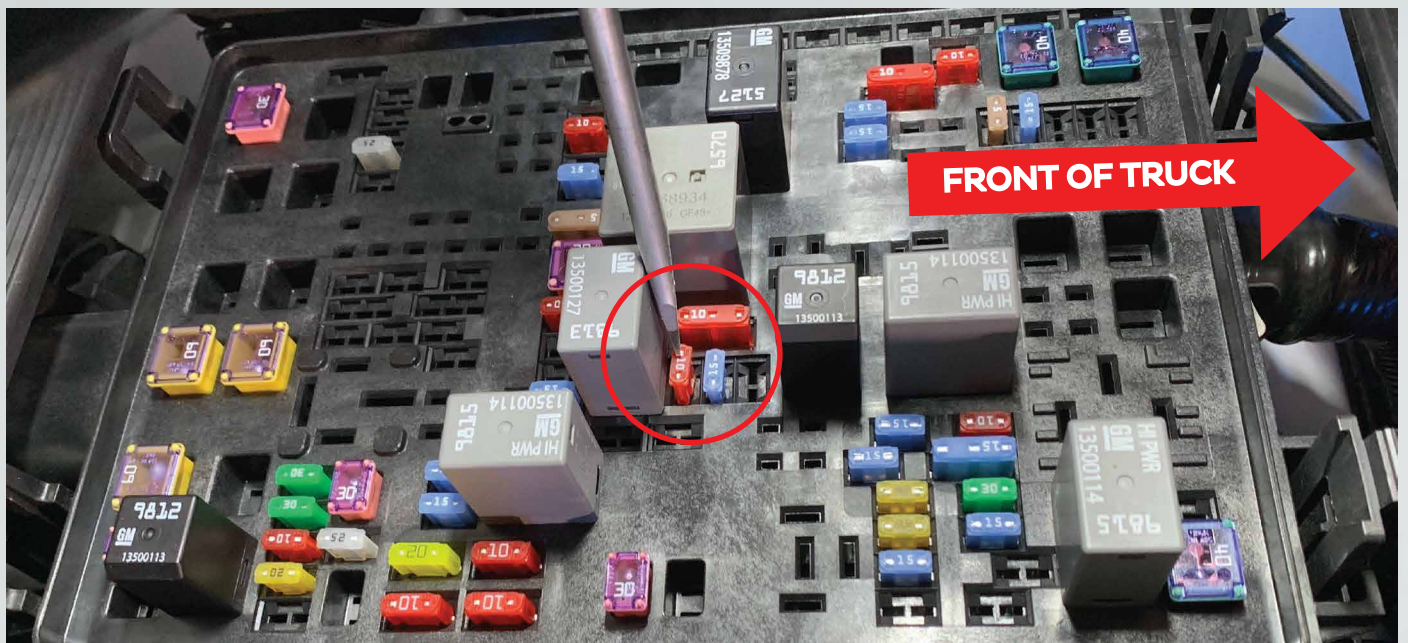
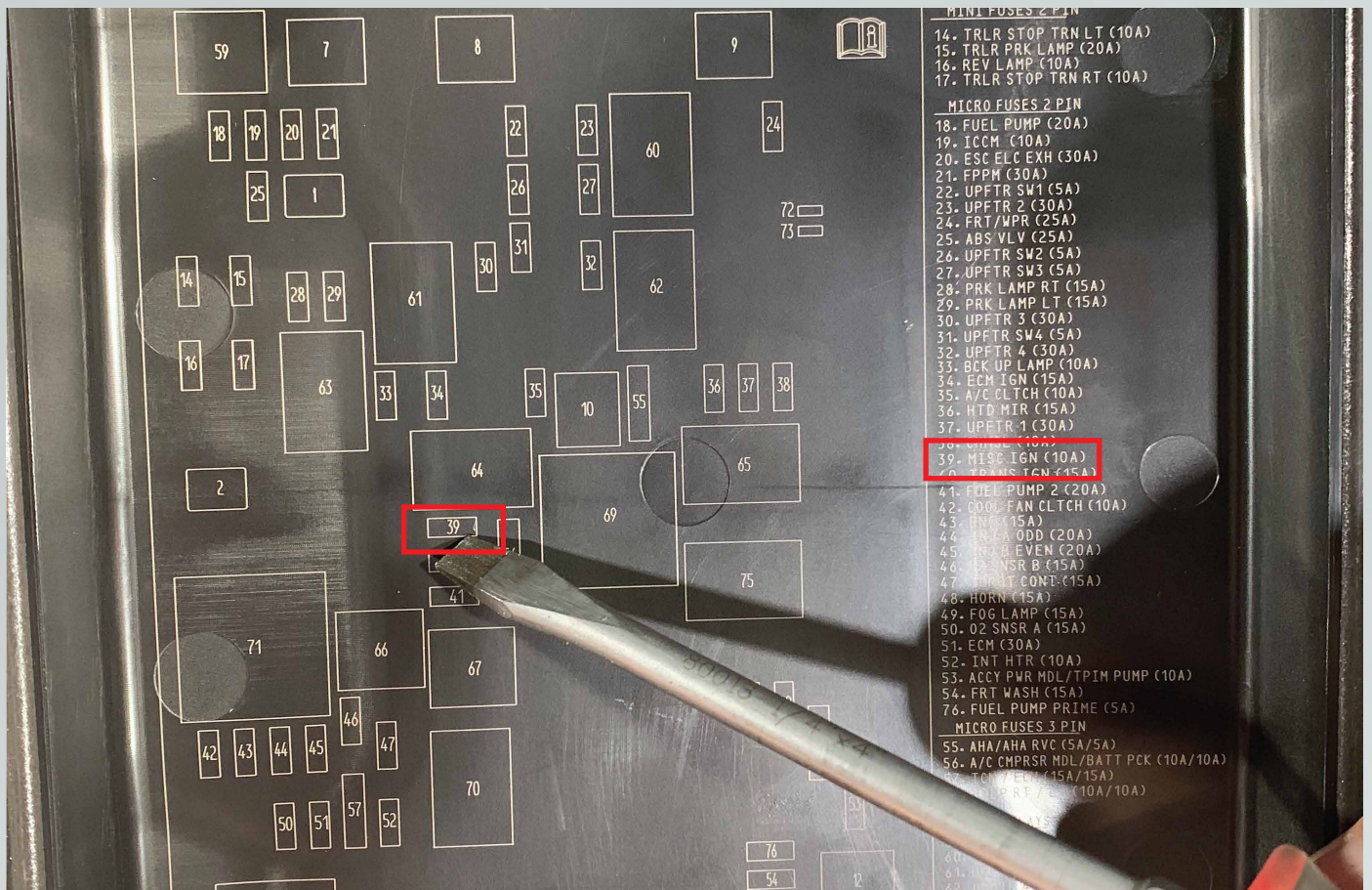

17. Locate the supplied DRL harness and plug it in the spot where you just removed a fuse.

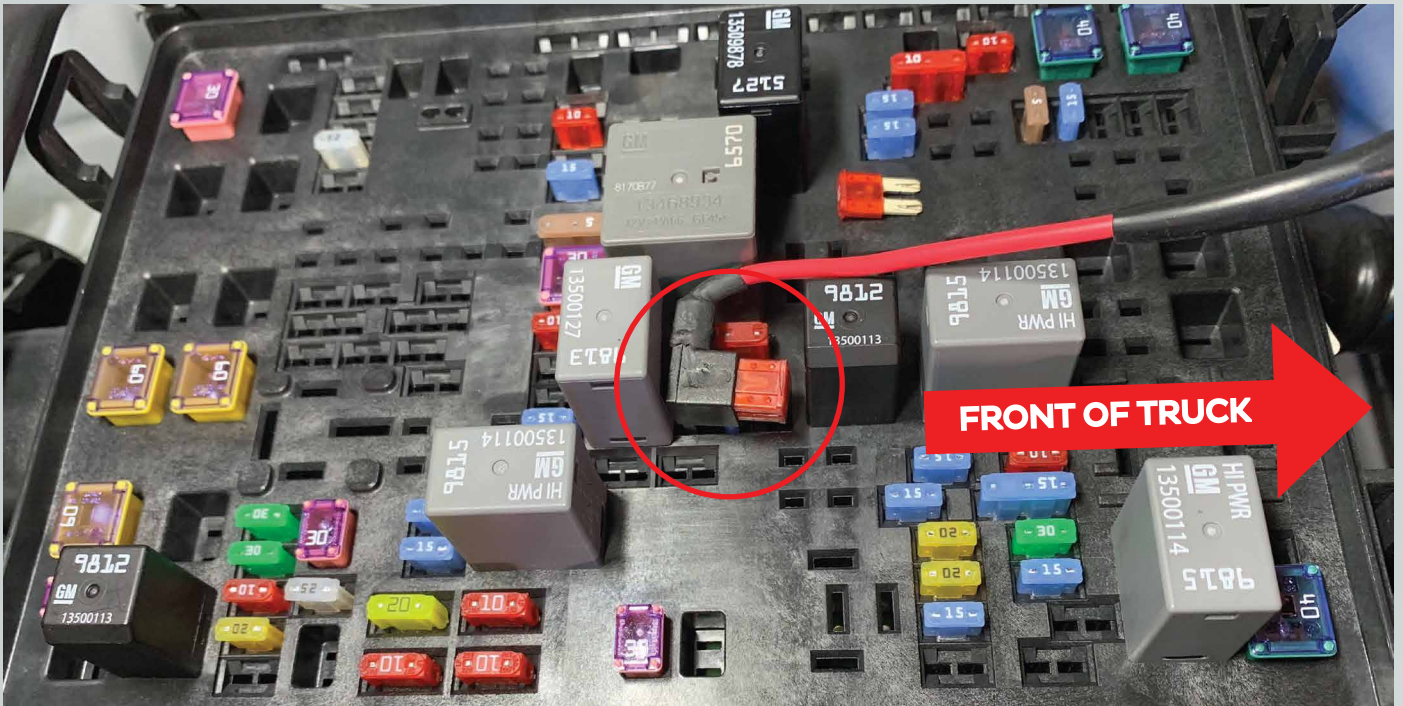

18. Run the short side of the DRL harness to the driver headlight area and the long side to the passenger headlight area.

19. Grad one XB headlight and plug in the connector from the headlight to the truck connector.

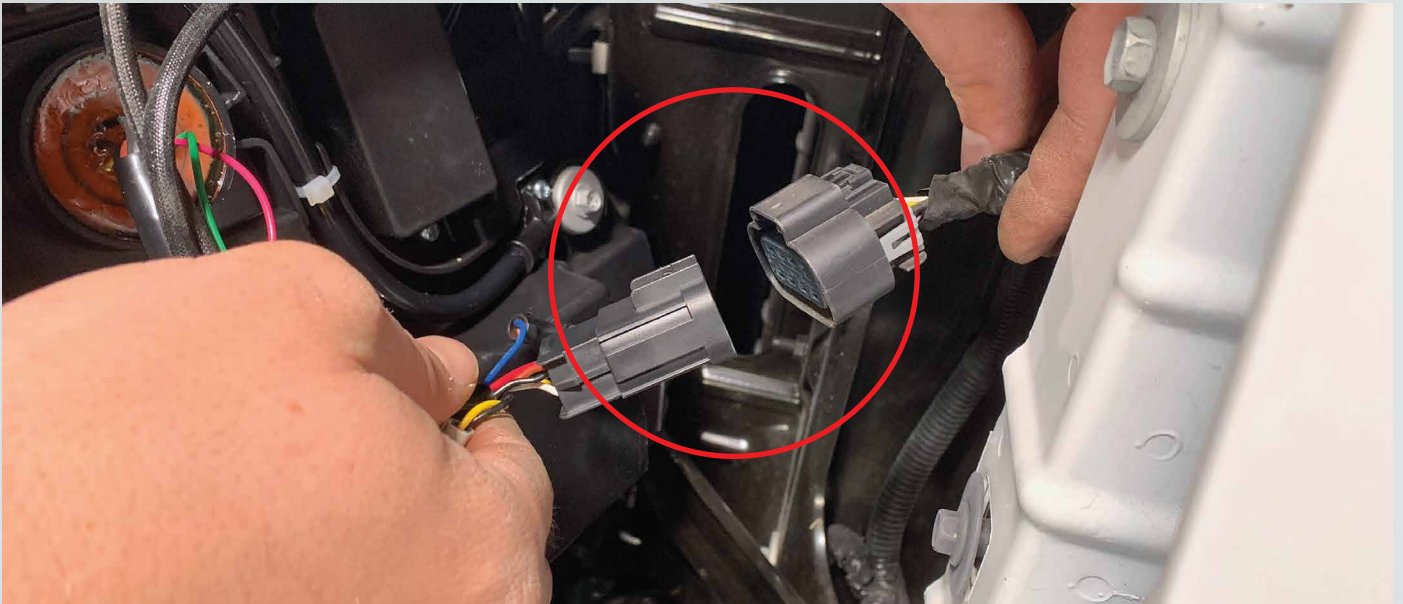

20. Plug in the DRL harness that you previously ran into the headlight connector with the blue wire.



21. To have a sequential turn signal leave these 2 connectors unplugged. To have a solid turn signal simply plug these 2 connectors into each other.

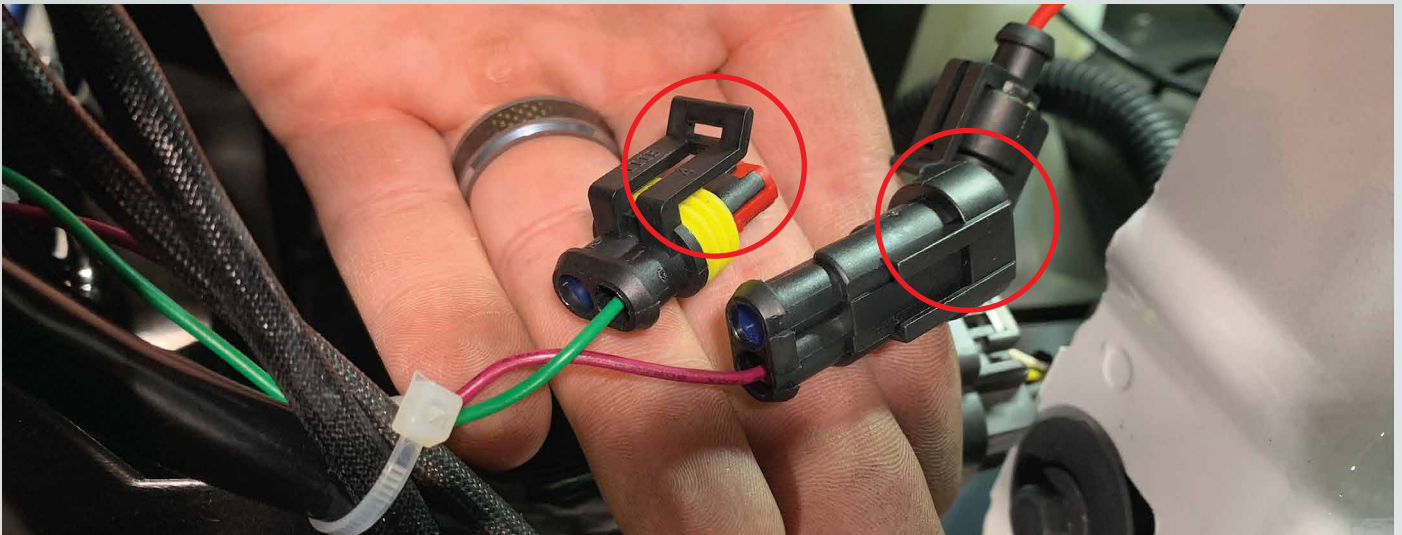

22. Repeat step 19-21 on the other side of the truck.

23. Turn the truck on and test all of the functions to make sure everything works.

24. Reassemble the truck in the reverse order that you took it apart.

25. Refer to the picture below to guide on how to aim your XB headlights.

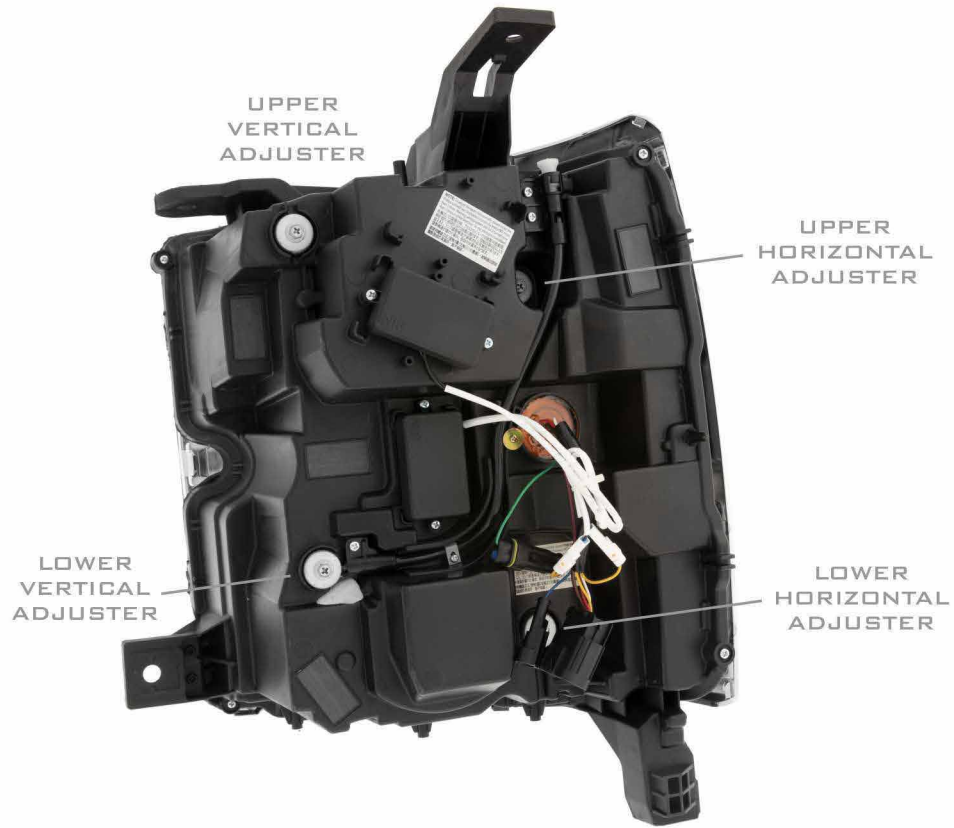

- Please refer to the aiming standards below when adjusting your headlight beam.

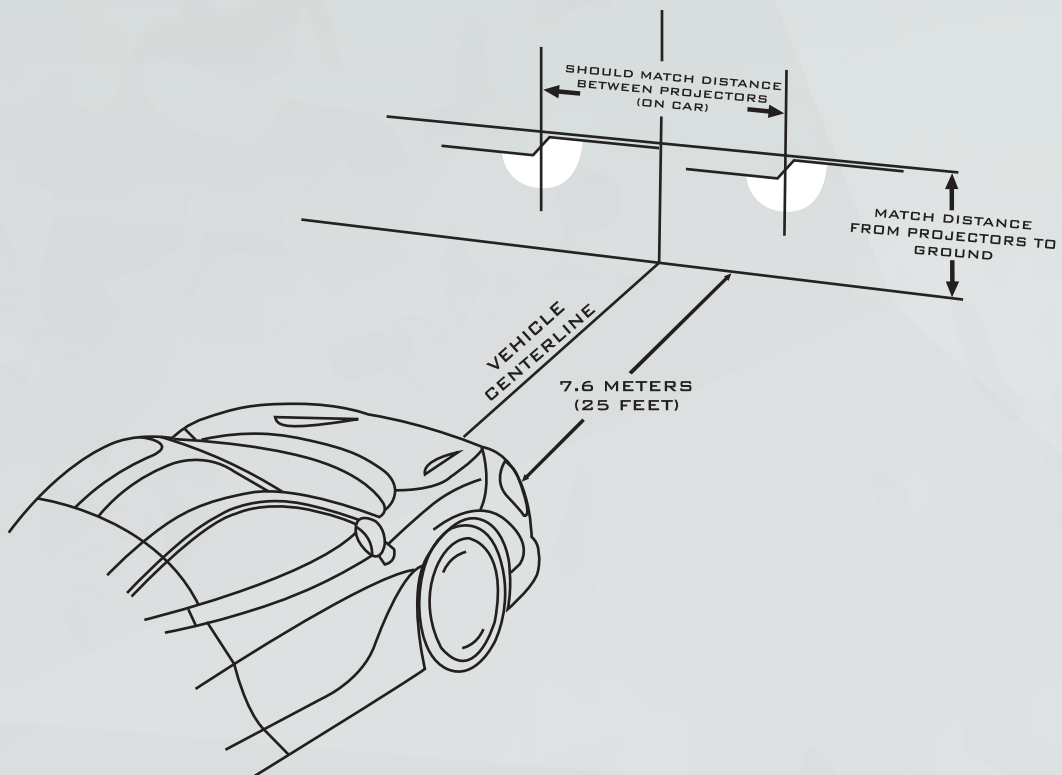

ENJOY YOUR NEW MORIMOTO XB HEADLIGHTS!

